

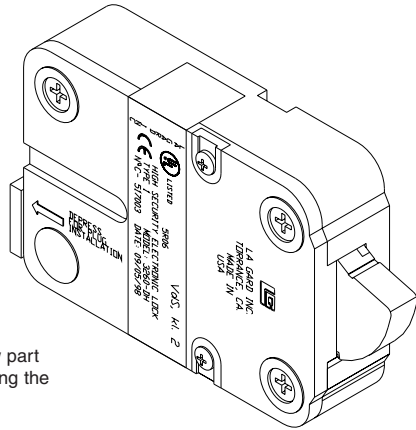

# LGBASIC

## 3765-2 / 4200 Dual-Handed Swingbolt Lock Instructions

### MANAGER PROGRAMMING



4200 is a new part number replacing the 3765-2

#### Suggested Keypads

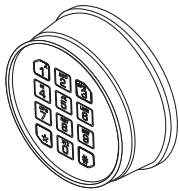

3000 Round Entry



3715 LGBASIC II Input

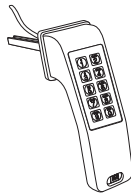

3900 LGACCESS Handle

#### FEATURES

##### MANAGER CODE (Factory set to 1-2-3-4-5-6)

- Add/Remove User
- Enable/Disable User

##### USER CODE

- Open Lock
- Change Code

##### WRONG TRY PENALTY

- Four (4) consecutive invalid codes initiates five minute delay period.

##### LOW BATTERY WARNING

- Repeated audio and visual signal (LED flashing and repeated beeping) during opening indicates battery low.

##### AUDIO AND VISUAL SIGNAL

- Double signal (LED flashes and unit beeps) indicates entry is valid or accepted.
- Triple signal indicates invalid or not accepted.

##### OPENING THE LOCK

- ① Enter valid six (6) digit code.
- ② The lock will signal a valid code entry with a double signal.
- ③ Within four (4) seconds, turn handle to the open position.
- ④ Pull door open.

- **Invalid Code Entry** - Lock will signal three (3) times.
- **Security Considerations** - On safes using more than one lock the swingbolt must lock first.

#### CHANGING YOUR CODE

##### ALWAYS PERFORM THIS OPERATION WITH THE DOOR OPEN

- ① Enter "zero" six times.
- ② Enter your existing six (6) digit code one time.
- ③ Enter your NEW six (6) digit code two times.
- ④ If a mistake is made wait thirty (30) seconds and repeat steps ① - ③.
- ⑤ Test lock operation several times before closing the door.

- **Valid Code Entry** - Double signal after valid six (6) digit code is entered.
- **Invalid Code Entry** - Triple signal and old code is still valid.

#### ADD USER

##### ALWAYS PERFORM THIS OPERATION WITH THE DOOR OPEN

- ① Enter Manager code and HOLD DOWN LAST DIGIT of CODE until the lock signals with two sets of double beeps.
- ② PRESS 1. Lock signals twice.
- ③ Enter user code twice. The lock signals twice after each valid entry.
- ④ If a mistake is made wait thirty (30) seconds and repeat steps ① - ③.

- **Valid Code Entry** - Double signal after valid six (6) digit code is entered.
- **Invalid Code Entry** - Triple signal and old code is still valid.

#### DISABLE USER

##### ALWAYS PERFORM THIS OPERATION WITH THE DOOR OPEN

- ① Enter Manager code and HOLD DOWN LAST DIGIT of CODE until the lock signals with two sets of double beeps.
- ② PRESS 2. Lock signals once.
- ③ User is temporarily disabled.
- ④ If a mistake is made wait thirty (30) seconds and repeat steps ① - ③.

- **Valid Code Entry** - Double signal after valid six (6) digit code is entered.
- **Invalid Code Entry** - Triple signal and old code is still valid.

#### REINSTATE USER

##### ALWAYS PERFORM THIS OPERATION WITH THE DOOR OPEN

- ① Enter Manager code and HOLD DOWN LAST DIGIT of CODE until the lock signals with two sets of double beeps.
- ② PRESS 1. Lock signals once.
- ③ User is reinstated.
- ④ If a mistake is made wait thirty (30) seconds and repeat steps ① - ③.

- **Valid Code Entry** - Double signal after valid six (6) digit code is entered.
- **Invalid Code Entry** - Triple signal and old code is still valid.

## REMOVE USER

### ALWAYS PERFORM THIS OPERATION WITH THE DOOR OPEN

- ① Enter Manager code and HOLD DOWN LAST DIGIT of CODE until the lock signals with two sets of double beeps.
  - ② PRESS 3. Lock signals once.
  - ③ User is permanently removed.
  - ④ If a mistake is made wait thirty (30) seconds and repeat steps ① - ③.
- **Valid Code Entry** - Double signal after valid six (6) digit code is entered.
  - **Invalid Code Entry** - Triple signal and old code is still valid.

## WRONG TRY PENALTY

- Entry of four (4) consecutive invalid codes starts a 5-minute delay period.
  - LED flashes red at five (5) second intervals.
- At the end of the delay period, two more consecutive invalid codes will restart an additional 5-minute delay period.

## BATTERY LOW WARNING

- Repeated beeping during an opening indicates that the battery is low and needs immediate replacement.
- Uses one (1) 9-Volt Alkaline Battery. LA GARD recommends the use of Duracell™ or Eveready™ Alkaline batteries. LA GARD recommends the replacement of batteries at least once annually.
- **If battery is depleted and will not allow lock to open, simply follow instructions below. Lock contains a non-volatile memory, even with the batteries removed the lock will retain all programming.**

## CHANGING YOUR BATTERY

- ① Slide the keypad housing up  and carefully pull away from mounting surface to expose battery compartment.
- ② Remove 9-Volt Alkaline battery and replace with new one.
- ③ The connector is easily removed by unsnapping it from the two terminals on the top of the battery.

### CAUTION! Hold onto battery terminal to avoid pulling wires out of housing

- ④ Carefully position the keypad over the mounting screws and slide the keypad housing down. Ensure that there are no wires or cables trapped between the input pad and the safe door. Pinched cables can result in a short circuit.

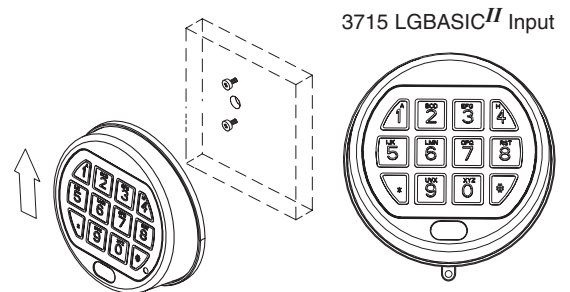

## CHANGING YOUR BATTERY (3000 Round Entry)

- ① Slide the keypad housing up  and carefully pull away from mounting surface to expose battery compartment.
- ② Remove one (1) 9-Volt Alkaline battery and replace with new one.
- ③ The connector is easily removed by unsnapping it from the two terminals on the top of the battery.

### CAUTION! Hold onto battery terminal pad to avoid pulling wires out of housing.

- ④ Repeat procedure for second battery.
- ⑤ Carefully position the keypad over the mounting screws and slide the keypad housing down.

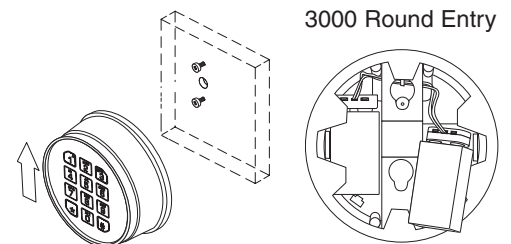

## CHANGING YOUR BATTERY (3900 LGACCESS Handle)

- ① Using a ballpoint pen, remove black plastic battery compartment cover (located on the back of the handle) by inserting the tip in the hole on the bottom of the handle. Remove compartment cover to access the battery.
- ② Gently pull on the battery until it drops out of the handle.
- ③ The connector is easily removed by unsnapping it from the two terminals on the top of the battery.

### Never Pull on the Battery Leads

- ④ Connect a new 9-Volt Alkaline battery to the battery clip.
- ⑤ Gently push the battery and the leads completely up into the battery compartment.
- ⑥ Re-install the battery cover by sliding the top portion in and gently snap the bottom into place.

